

**DLC Display Co., Limited**

德爾西顯示器有限公司



MODEL No:DLC0700DDG-4

TEL: 86-755-86029824

FAX: 86-755-86029827

E-MAIL: [sales@dlcdisplay.com](mailto:sales@dlcdisplay.com)

WEB: [www.dlcdisplay.com](http://www.dlcdisplay.com)



### Record of Revision

| Date       | Revision No. | Summary              |
|------------|--------------|----------------------|
| 2013-06-25 | 1.0          | Rev 1.0 was issued   |
| 2013-09-06 | 1.1          | Update the luminance |
|            |              |                      |

## 1. Scope

This data sheet is to introduce the specification of DLC0700DDG-4, active matrix TFT module. It is composed of a color TFT-LCD panel, driver ICs, FPC and a backlight unit. The 7.0" display area contains 800X3 (RGB) x 480 pixels.

## 2. Application

Digital equipments which need color display, mobile navigator/video systems.

## 3. General Information

| Item                          | Contents                     | Unit |
|-------------------------------|------------------------------|------|
| Size                          | 7.0                          | inch |
| Resolution                    | 800X3(RGB) x 480             | /    |
| Interface                     | LVDS                         | /    |
| Technology type               | a-Si TFT                     | /    |
| Pixel pitch                   | 0.1926x0.1790                | mm   |
| Pixel Configuration           | R.G.B. Stripe                |      |
| Outline Dimension (W x H x D) | 164.9X100.0X9.6              | mm   |
| Active Area                   | 154.08X85.92                 | mm   |
| Display Mode                  | Transmissive, Normally white | /    |
| Backlight Type                | LED                          | /    |

### 4. Outline Drawing

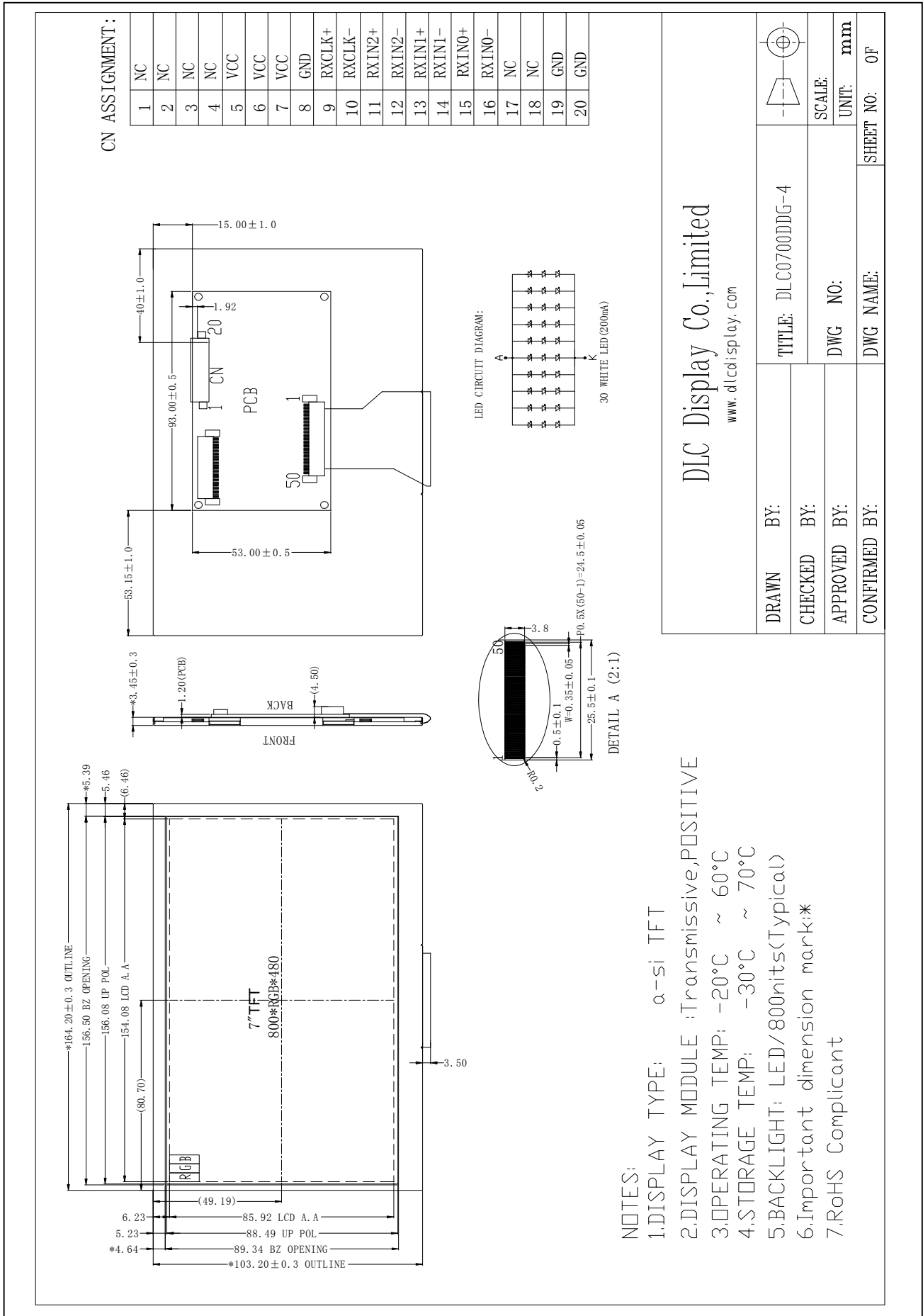

## 5. Interface signals

| No | Symbol | Description                             | Remark |
|----|--------|---|--------|
| 1  | NC     | NC                                      |        |
| 2  | NC     | NC                                      |        |
| 3  | NC     | NC                                      |        |
| 4  | NC     | NC                                      |        |
| 5  | VCC    | +5.0V                                   |        |
| 6  | VCC    | +5.0V                                   |        |
| 7  | VCC    | +5.0V                                   |        |
| 8  | GND    | Power Ground                            |        |
| 9  | RXCLK+ | Differential Clock Input ((Positive)    |        |
| 10 | RXCLK- | Differential Clock Input Negative)      |        |
| 11 | RXIN2+ | Differential Data Input ,CH2 (Positive) |        |
| 12 | RXIN2- | Differential Data Input ,CH2 (Negative) |        |
| 13 | RXIN1+ | Differential Data Input ,CH1 (Positive) |        |
| 14 | RXIN1- | Differential Data Input ,CH1 (Negative) |        |
| 15 | RXIN0+ | Differential Data Input ,CH0(Positive)  |        |
| 16 | RXIN0- | Differential Data Input ,CH0(Negative)  |        |
| 17 | NC     | NC                                      |        |
| 18 | NC     | NC                                      |        |
| 19 | GND    | Power Ground                            |        |
| 20 | GND    | Power Ground                            |        |

## 6. Absolute maximum Ratings

### 6.1. Electrical Absolute max. ratings

| Parameter     | Symbol  | MIN   | MAX  | Unit | Remark |
|---------------|---------|-------|------|------|--------|
| Power voltage | DVDD    | -0.3  | 5.0  | V    |        |
|               | AVDD    | 6.5   | 13.5 | V    |        |
|               | VGH     | -0.3  | 40.0 | V    |        |
|               | VGL     | -20.0 | 0.3  | V    |        |
|               | VGH-VGL | --    | 40.0 | V    |        |

### 6.2. Environment Conditions

| Item                  | Symbol | MIN | MAX | Unit | Remark |
|-----------------------|--------|-----|-----|------|--------|
| Operating Temperature | TOPR   | -20 | 60  | °C   |        |
| Storage Temperature   | TSTG   | -30 | 70  | °C   |        |

## 7. Electrical Specifications

### 7.1 Electrical characteristics

GND=0V, Ta=25°C

| Item                     | Symbol | MIN      | TYP  | MAX      | Unit | Remark |
|--------------------------|--------|----------|------|----------|------|--------|
| Input signal voltage     | VCOM   | 3.6      | 3.8  | 4.0      | V    |        |
| Input logic high voltage | VIH    | 0.7 DVDD | -    | DVDD     | V    | NOTE3  |
| Input logic low voltage  | VIL    | 0        | -    | 0.3 DVDD | V    | NOTE3  |
| Power voltage            | DVDD   | 3        | 3.3  | 3.6      | V    | NOTE2  |
|                          | AVDD   | 10.2     | 10.4 | 10.6     | V    |        |
|                          | VGH    | 15.3     | 16.0 | 16.7     | V    |        |
|                          | VGL    | -7.7     | -7   | -6.3     | V    |        |

Note 1: Be sure to apply DVDD and VGL to the LCD first, and then apply VGH.

Note 2: DVDD setting should match the signals output voltage (refer to Note 3) of customer's system board.

Note 3: DCLK,HS,VS,RESET,U/D, L/R,DE,R0~R7,G0~G7,B0~B7,MODE,DITHB.

### 7.2 Current Consumption

| Item               | Symbol | MIN | TYP | MAX | Unit | Remark      |
|--------------------|--------|-----|-----|-----|------|-------------|
| Current for Driver | IGH    | --  | 0.2 | 1.0 | mA   | VGH =16.0V  |
|                    | IGL    | --  | 0.2 | 1.0 | mA   | VGL = -7.0V |
|                    | IDVDD  | --  | 4.0 | 10  | mA   | DVDD =3.3V  |
|                    | IAVDD  | --  | 20  | 50  | mA   | AVDD =10.4V |

### 7.3 LED Backlight

Ta=25°C

| Item            | Symbol | MIN | TYP   | MAX | Unit | Remark |
|-----------------|--------|-----|-------|-----|------|--------|
| Forward Current | IL     | -   | 200   |     | mA   |        |
| Forward Voltage | VL     | -   | 9.3   | -   | V    | Note1  |
| LED life time   | --     | --  | 30000 | --  | Hr   | Note2  |

Note 1: The LED Supply Voltage is defined by the number of LED at Ta=25°C and IL =200mA.

Note 2: The "LED life time" is defined as the module brightness decrease to 50% original brightness at Ta=25°C and IL =180mA. The LED lifetime could be decreased if operating IL is larger than 180mA.

## 8. Command/AC Timing

### 8.1 AC Electrical Characteristics

| Item                    | Symbol | Rating |     |     | Unit | Remark             |
|-------------------------|--------|--------|-----|-----|------|--------------------|
|                         |        | MIN    | TYP | MAX |      |                    |
| HS setup time           | Thst   | 8      | -   | -   | ns   |                    |
| HS hold time            | Thhd   | 8      | -   | -   | ns   |                    |
| VS setup time           | Tvst   | 8      | -   | -   | ns   |                    |
| VS hold time            | Tvhd   | 8      | -   | -   | ns   |                    |
| Data setup time         | Tdsu   | 8      | -   | -   | ns   |                    |
| Data hole time          | Tdhd   | 8      | -   | -   | ns   |                    |
| DE setup time           | Tesu   | 8      | -   | -   | ns   |                    |
| DE hole time            | Tehd   | 8      | -   | -   | ns   |                    |
| DVDD Power On Slew rate | TPOR   | -      | -   | 20  | ms   | From 0 to 90% DVDD |
| RESET pulse width       | TRst   | 1      | -   | -   | ms   |                    |
| DCLK cycle time         | Tcoh   | 20     | -   | -   | ns   |                    |
| DCLK pulse duty         | Tcwh   | 40     | 50  | 60  | %    |                    |

### 8.2 Input Clock and Data Timing Diagram

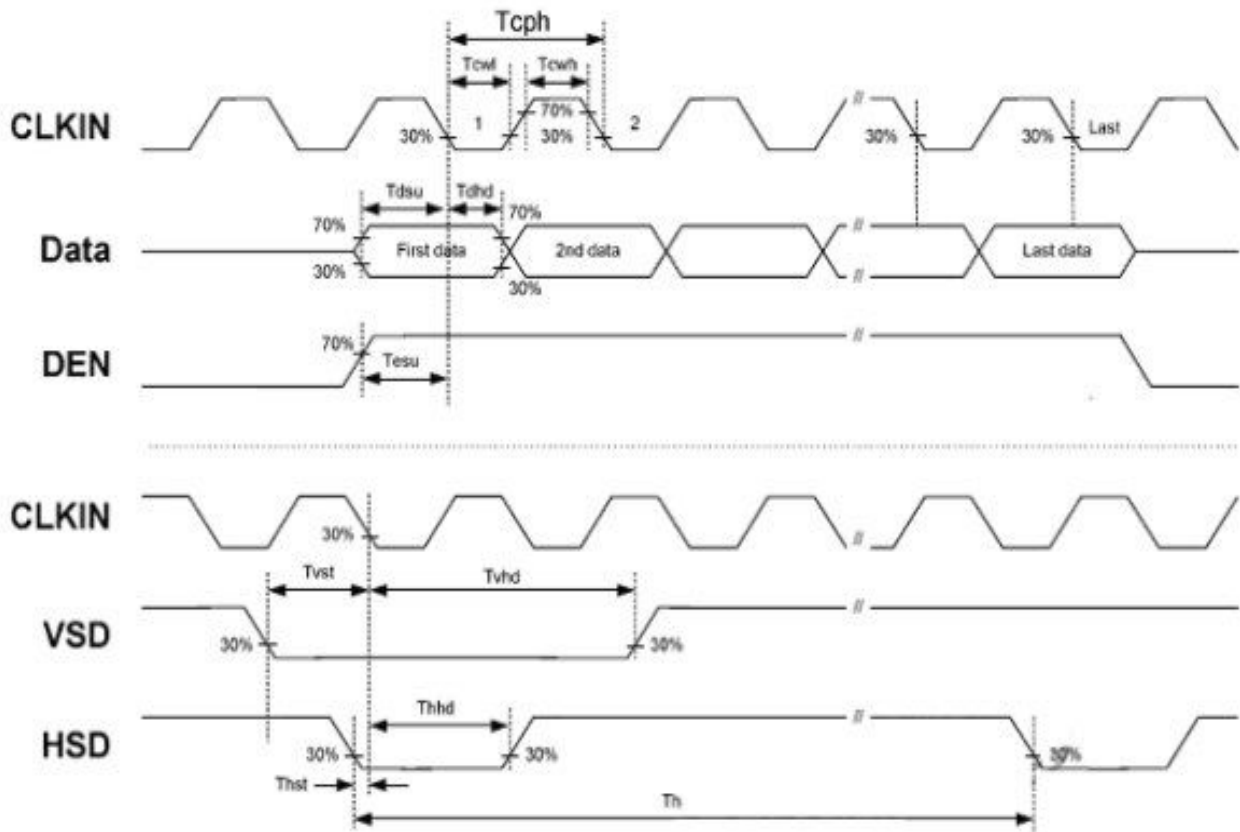



## 8.3 Timing

| Item                    | Symbol | Rating |      |      | Unit | Remark |
|-------------------------|--------|--------|------|------|------|--------|
|                         |        | MIN    | TYP  | MAX  |      |        |
| Horizontal Display Area | Thd    | --     | 800  | --   | DCLK |        |
| DCLK Frequency          | Fclk   | 26.4   | 33.3 | 46.8 | MHZ  |        |
| One Horizontal Line     | Th     | 862    | 1056 | 1200 | DCLK |        |
| HS pulse width          | Thpw   | 1      | --   | 40   | DCLK |        |
| HS Blanking             | thb    | 46     | 46   | 46   | DCLK |        |
| HS Front Porch          | thfp   | 16     | 210  | 354  | DCLK |        |

| Item                  | Symbol | Rating |     |     | Unit | Remark |
|-----------------------|--------|--------|-----|-----|------|--------|
|                       |        | MIN    | TYP | MAX |      |        |
| Vertical Display Area | Tvd    | --     | 480 | --  | TH   |        |
| VS period time        | Tv     | 510    | 525 | 650 | TH   |        |
| VS pulse width        | Tvpw   | 1      | --  | 20  | TH   |        |
| VS Blanking           | tvb    | 23     | 23  | 23  | TH   |        |
| VS Front Porch        | tvfp   | 7      | 22  | 14  | TH   |        |

## 8.4 Data Input Format

### 8.4.1. horizontal input timing diagram



### 8.4.2. Vertical input timing diagram

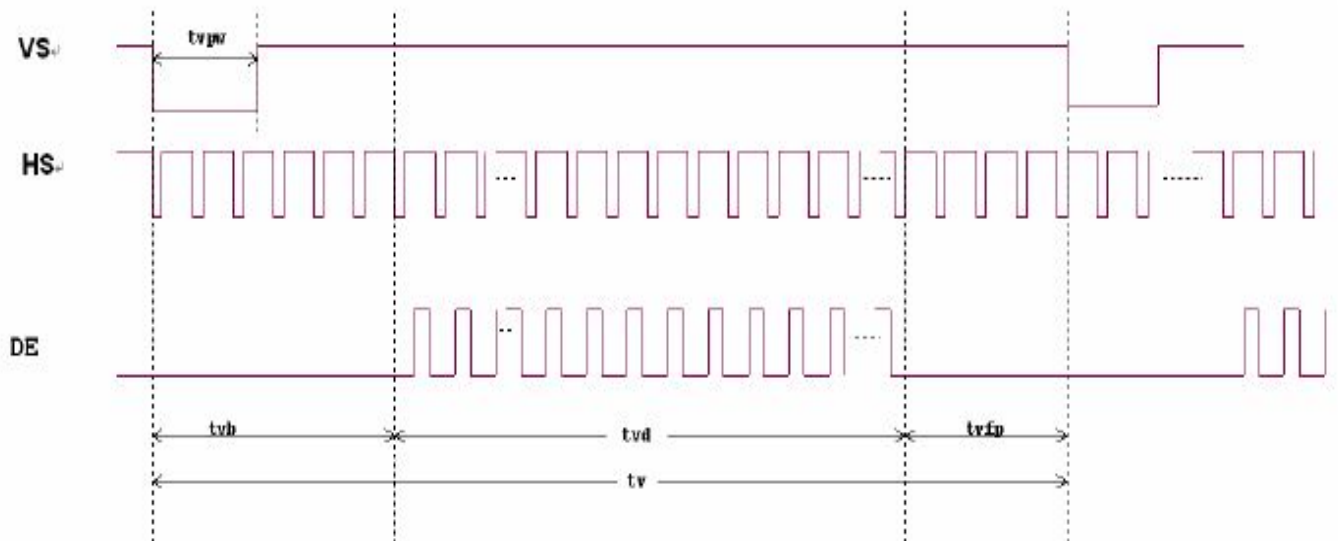

### 8.5 Power ON/Off Sequence

#### a. Power on

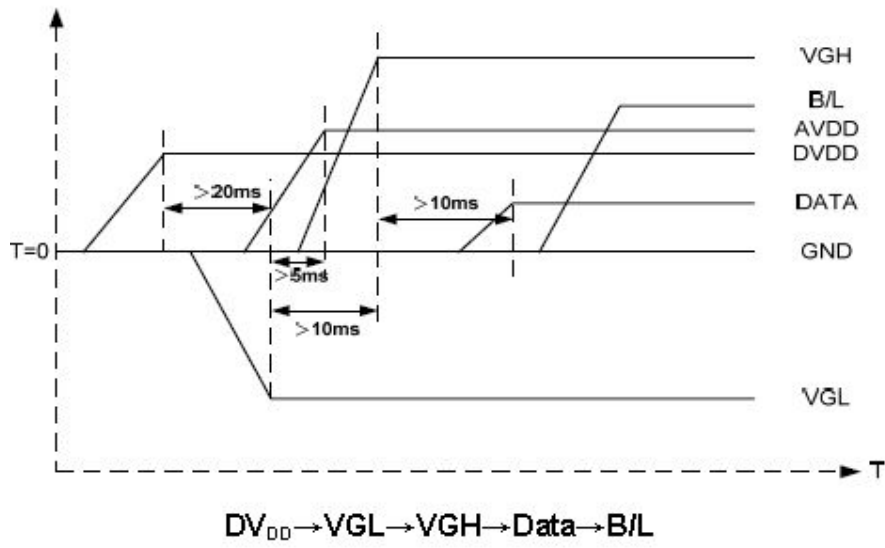

#### b. Power off

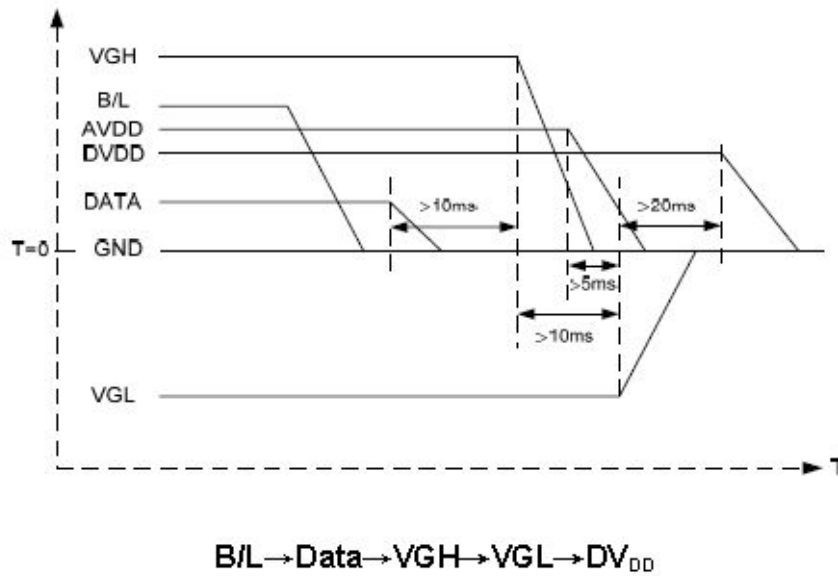

Note: Data include R0~R7, B0~B7, G0~G7, U/D, L/R, DCLK, HS, VS, DE.

9. Optical Specification

Ta=25°C

| Item           | Symbol     | Condition        | Min | Typ. | Max. | Unit              | Remark          |
|----------------|------------|------------------|-----|------|------|-------------------|-----------------|
| Contrast Ratio | CR         | $\theta=0^\circ$ | 400 | 500  | -    |                   | Note1<br>Note2  |
| Response Time  | Ton        | 25°C             | -   | 10   | 20   | ms                | Note1<br>Note3  |
|                | Toff       |                  | -   | 15   | 30   |                   |                 |
| View Angles    | $\theta T$ | $CR \geq 10$     | 40  | 50   | -    | Degree            | Note 4          |
|                | $\theta B$ |                  | 60  | 70   | -    |                   |                 |
|                | $\theta L$ |                  | 60  | 70   | -    |                   |                 |
|                | $\theta R$ |                  | 60  | 70   | -    |                   |                 |
| Chromaticity   | White      | Brightness is on | x   | 0.30 | 0.32 | 0.34              | Note5,<br>Note1 |
|                |            |                  | y   | 0.32 | 0.34 | 0.36              |                 |
| Luminance      | L          |                  | -   | 700  | -    | cd/m <sup>2</sup> | Note1<br>Note6  |
| Uniformity     | U          |                  | 75  |      | -    | %                 | Note1<br>Note7  |

Test condition: DVDD=3.3V, the ambient temperature is 25°C.

**Note 1: Definition of optical measurement system.**

Temperature = 25°C(±3°C)

LED back-light: ON, Environment brightness < 150 lx

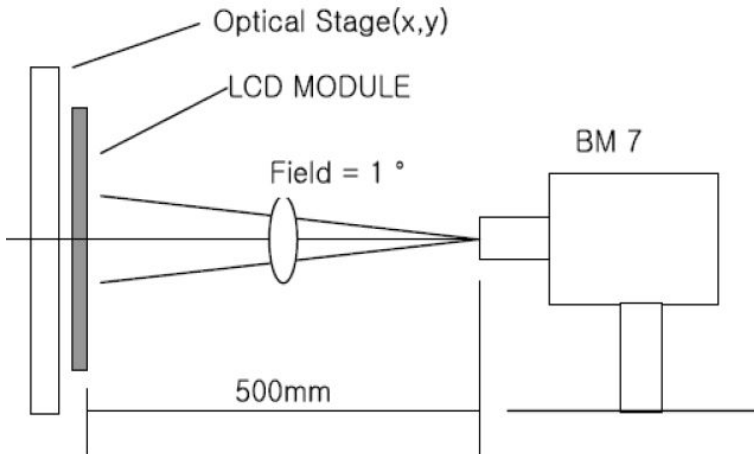

**Note 2: Contrast ratio is defined as follow:**

$$\text{Contrast Ratio} = \frac{\text{Surface Luminance with all white pixels}}{\text{Surface Luminance with all black pixels}}$$

**Note 3: Response time is defined as follow:**

Response time is the time required for the display to transition from black to white (Rise Time,  $T_r$ ) and from white to black(Decay Time,  $T_f$ ).

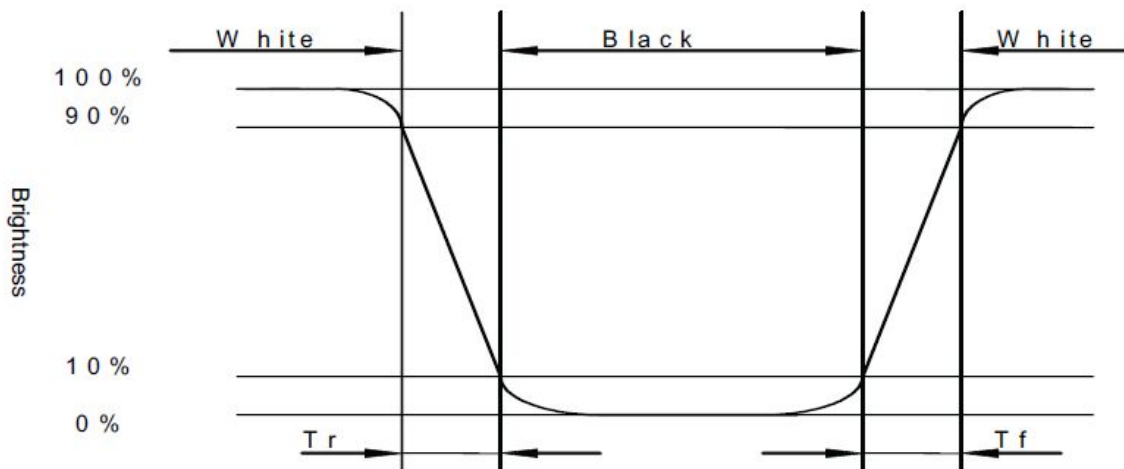

Note 4: Viewing angle range is defined as follow:

Viewing angle is measured at the center point of the LCD.

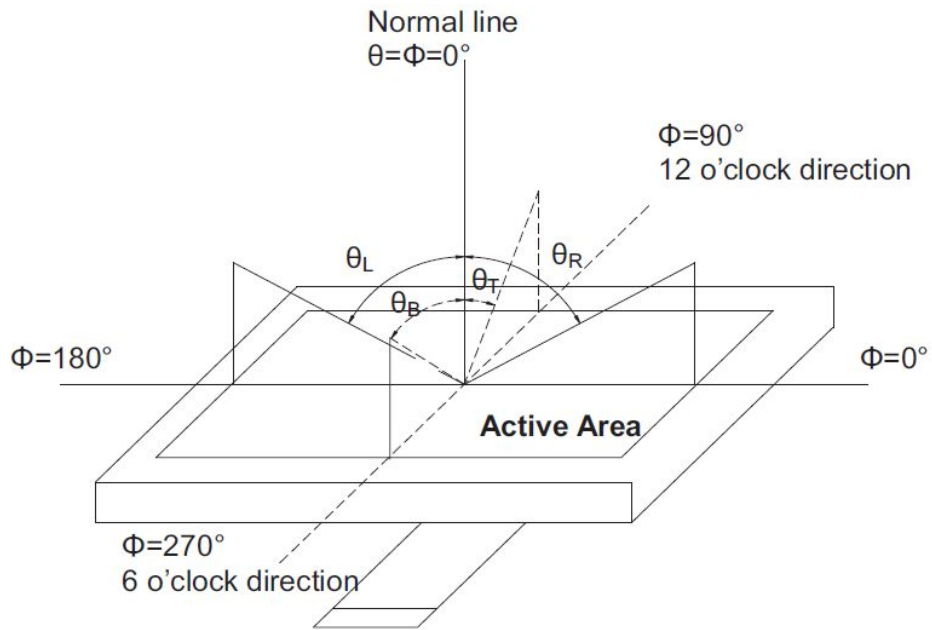

Note 5: Color chromaticity is defined as follow: (CIE1931)

Color coordinates measured at center point of LCD.

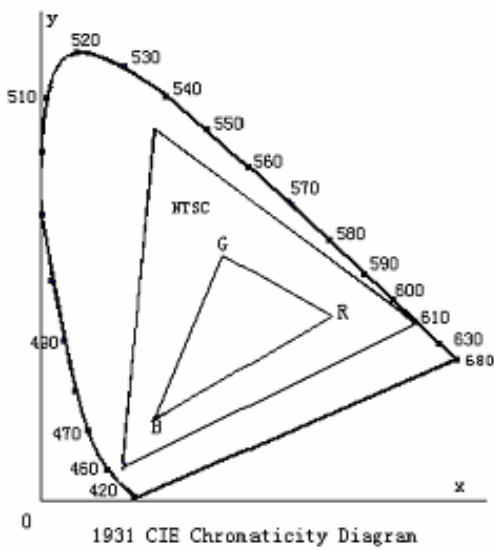

$$S = \frac{\text{area of RGB triangle}}{\text{area of NTSC triangle}} \times 100\%$$

Note 6: Luminance is defined as follow:

Luminance is defined as the brightness of all pixels “White” at the center of display area on optimum contrast.

Note 7: Luminance Uniformity is defined as follow:

Active area is divided into 9 measuring areas (Refer Fig. 2). Every measuring point is placed at the center of each measuring area.

$$\text{Uniformity (U)} = \frac{\text{Minimum Luminance( brightness ) in 9 points}}{\text{Maximum Luminance( brightness ) in 9 points}}$$

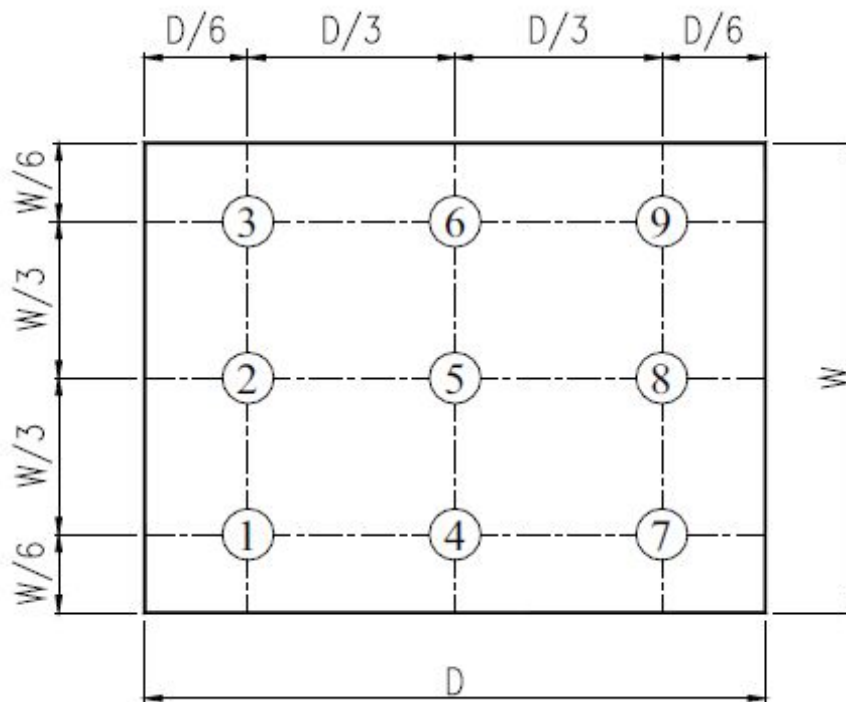

Fig. 2 Definition of uniformity

## 10. Environmental / Reliability Tests

| No | Test Item                         | Condition  | Judgment criteria   |
|----|-----------------------------------|--|---|
| 1  | High Temp Operation               | Ts=+60°C, 120hrs   | Per table in below  |
| 2  | Low Temp Operation                | Ta=-20°C, 120hrs   | Per table in below  |
| 3  | High Temp Storage                 | Ta=+70°C, 120hrs   | Per table in below  |
| 4  | Low Temp Storage                  | Ta=-30°C, 120hrs   | Per table in below  |
| 5  | High Temp & High Humidity Storage | Ta=+60°C, 90% RH<br>120 hours  | Per table in below<br>(polarizer discoloration is excluded) |
| 6  | Thermal Shock (Non-operation)     | -20°C 30 min~+70°C 30 min,<br>Change time:5min, 10 Cycles  | Per table in below  |
| 7  | ESD (Operation)                   | C=150pF, R=330Ω , 5points/panel<br>Air:±8KV, 5times;<br>Contact:±4KV, 5 times;                           | Per table in below  |
| 8  | Vibration (Non-operation)         | Frequency range:10~55Hz,<br>Stroke:1.5mm<br>Sweep:10Hz~55Hz~10Hz 2 hours<br>for each direction of X.Y.Z. | Per table in below  |
| 9  | Shock (Non-operation)             | 60G 6ms, ±X,±Y,±Z 3times,<br>for each direction  | Per table in below  |
| 10 | Package Drop Test                 | Height:80 cm,<br>1 corner, 3 edges, 6 surfaces   | Per table in below  |

| INSPECTION             | CRITERION(after test)   |
|------------------------|---|
| Appearance             | No Crack on the FPC, on the LCD Panel   |
| Alignment of LCD Panel | No Bubbles in the LCD Panel<br>No other Defects of Alignment in Active area         |
| Electrical current     | Within device specifications  |
| Function / Display     | No Broken Circuit, No Short Circuit or No Black line<br>No Other Defects of Display |



## 11. Precautions for Use of LCD Modules

### 11.1 Safety

The liquid crystal in the LCD is poisonous. Do not put it in your mouth. If the liquid crystal touches your skin or clothes, wash it off immediately using soap and water.

### 11.2 Handling

- A. The LCD and touch panel is made of plate glass. Do not subject the panel to mechanical shock or to excessive force on its surface.
- B. Do not handle the product by holding the flexible pattern portion in order to assure the reliability
- C. Transparency is an important factor for the touch panel. Please wear clear finger sacks, gloves and mask to protect the touch panel from finger print or stain and also hold the portion outside the view area when handling the touch panel.
- D. Provide a space so that the panel does not come into contact with other components.
- E. To protect the product from external force, put a covering lens (acrylic board or similar board) and keep an appropriate gap between them.
- F. Transparent electrodes may be disconnected if the panel is used under environmental conditions where dew condensation occurs.
- G. Property of semiconductor devices may be affected when they are exposed to light, possibly resulting in IC malfunctions.
- H. To prevent such IC malfunctions, your design and mounting layout shall be done in the way that the IC is not exposed to light in actual use.

### 11.3 Static Electricity

- A. Ground soldering iron tips, tools and testers when they are in operation.
- B. Ground your body when handling the products.
- C. Power on the LCD module before applying the voltage to the input terminals.
- D. Do not apply voltage which exceeds the absolute maximum rating.
- E. Store the products in an anti-electrostatic bag or container.

### 11.4 Storage

- A. Store the products in a dark place at  $+25^{\circ}\text{C} \pm 10^{\circ}\text{C}$  with low humidity (40% RH to 60% RH). Don't expose to sunlight or fluorescent light.
- B. Storage in a clean environment, free from dust, active gas, and solvent.

### 11.5 Cleaning

- A. Do not wipe the touch panel with dry cloth, as it may cause scratch.
- B. Wipe off the stain on the product by using soft cloth moistened with ethanol. Do not allow ethanol to get in between the upper film and the bottom glass. It may cause peeling issue or defective operation. Do not use any organic solvent or detergent other than ethanol.

### 11.6 Cautions for installing and assembling

Bezel edge must be positioned in the area between the Active area and View area. The bezel may press the touch screen and cause activation if the edge touches the active area. A gap of approximately 0.5mm is needed between the bezel and the top electrode. It may cause unexpected activation if the gap is too narrow. There is a tolerance of 0.2 to 0.3mm for the outside dimensions of the touch panel and tail. A gap must be made to absorb the tolerance in the case and connector.

